

7-2 Triangle Angle-Sum Theorem (ver 5)\_hw

Find the measure of each angle indicated.

1)

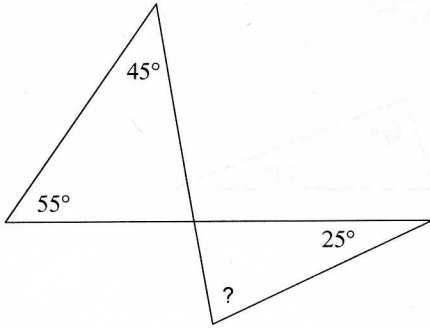

2)

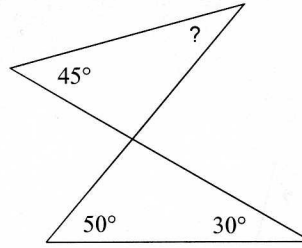

3)

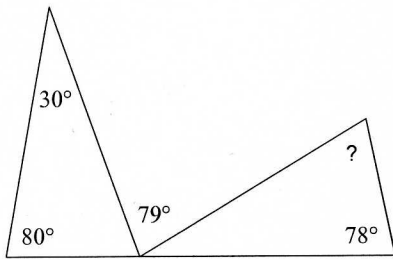

4)

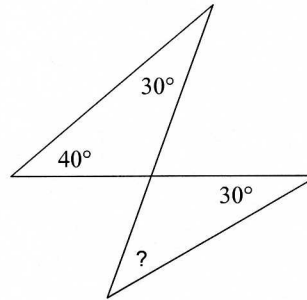

5)

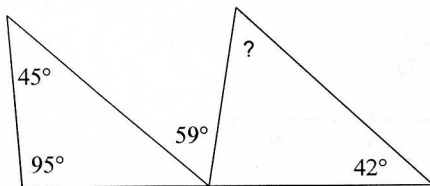

6)

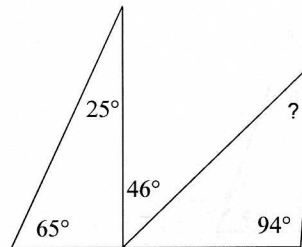

7)

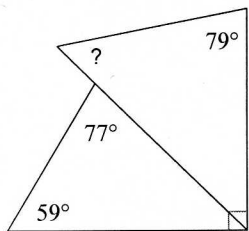

8)

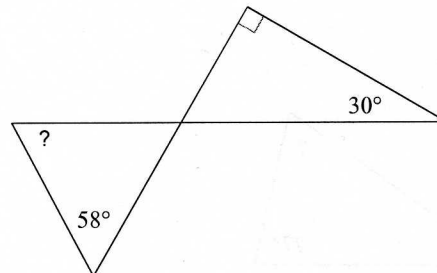

9)

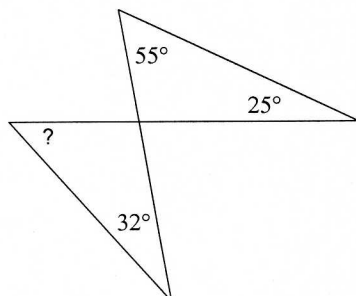

10)

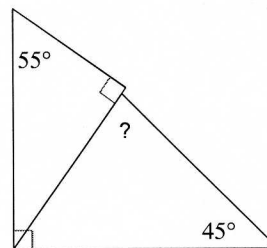

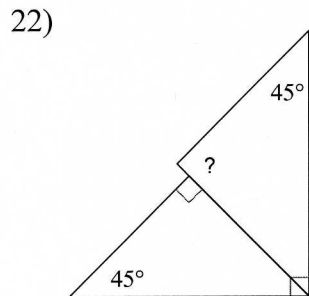
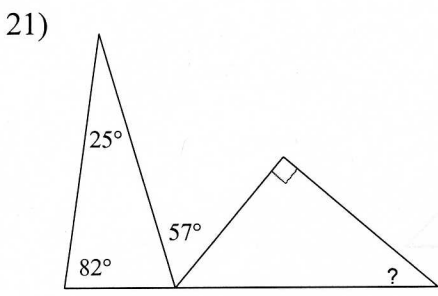
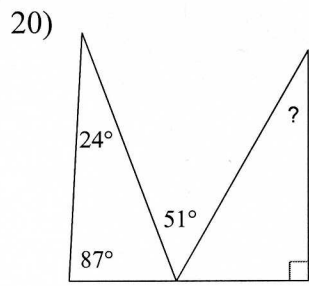
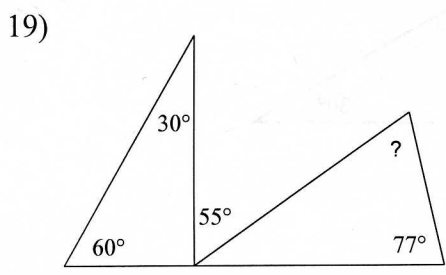
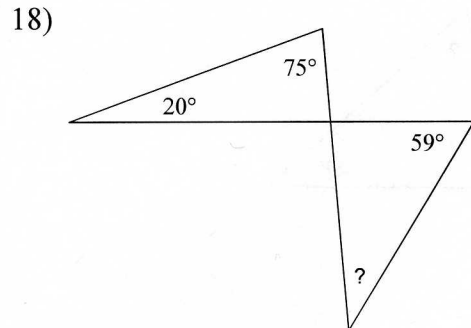
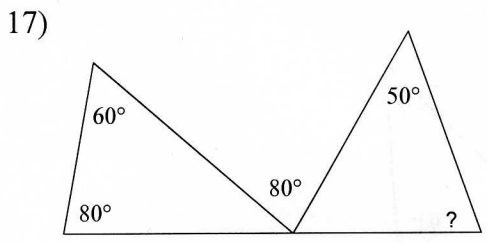
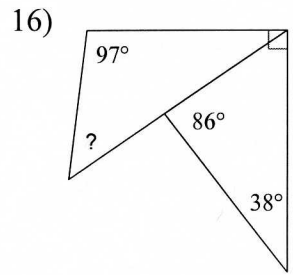
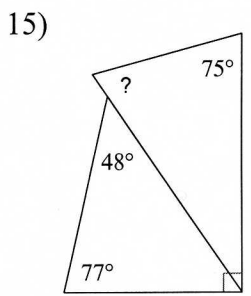
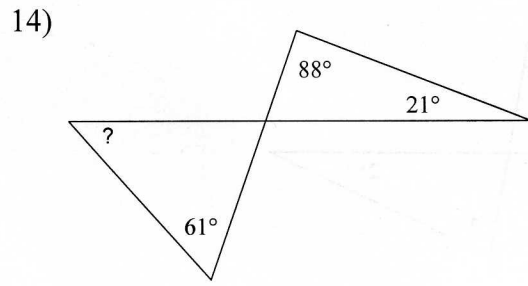
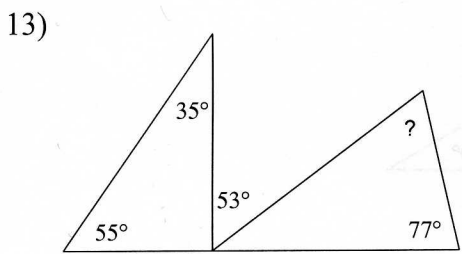
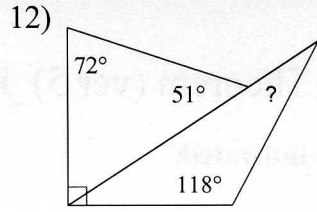
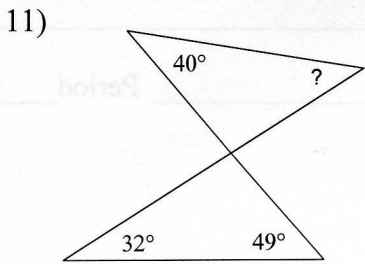

Answers to 7-2 Triangle Angle-Sum Theorem (ver 5) \_hw

- 1) 75°
- 2) 35°
- 3) 71°
- 4) 40°
- 5) 57°
- 6) 42°
- 7) 55°
- 8) 62°
- 9) 48°
- 10) 80°
- 11) 41°
- 12) 29°
- 13) 66°
- 14) 48°
- 15) 70°
- 16) 49°
- 17) 70°
- 18) 36°
- 19) 68°
- 20) 90°
- 21) 40°
- 22) 30°